

## **WIRES & CABLES DISCOUNTS**

**39% + GST - 90 Mtrs & FRLS**

**41% + GST - 180 Mtrs & 45 Mtrs**

**41% + GST - Core**

**41% + GST - Aluminium Wire**

**41% + GST - Submerible**

**CD 2 % on basic value**

**(0-15days only)**

**Upto 3 Credit Bills only**



## Maharaja® Wires & Cables

All India Price List - 2026

www.maharajawires.com / Sales@maharajawires.com

W.E.F - 21.MAY.2026



### PVC INSULATED SINGLE CORE - 90 Mtrs AS PER ISI

LP NO : 03/2105/26-27

Product Code	Conductor Area (Sq mm)	LIST PRICE	MASTER CARTON PACKING (NOS)
CW001	1.0 - 90 Mtrs	2060.00	20
CW002	1.5 - 90 Mtrs	3090.00	20
CW003	2.5 - 90 Mtrs	4940.00	18
CW004	4.0 - 90 Mtrs	7690.00	10
CW005	6.0 - 90 Mtrs	11520.00	7
CW006	10.0 - 90 Mtrs	19780.00	5

### PVC INSULATED SINGLE CORE - 180 Mtrs AS PER ISI

Product Code	Conductor Area (Sq mm)	LIST PRICE	MASTER CARTON PACKING (NOS)
CW007	1.0 - 180 Mtrs	4100.00	12
CW008	1.5 - 180 Mtrs	6040.00	12
CW009	2.5 - 180 Mtrs	9740.00	10
CW010	4.0 - 180 Mtrs	15120.00	6
CW011	6.0 - 180 Mtrs	22940.00	4

### PVC INSULATED SINGLE CORE - 45 Mtrs AS PER ISI

Product Code	Conductor Area (Sq mm)	LIST PRICE	MASTER CARTON PACKING (NOS)
CW012	1.0 - 45 Mtrs	1060.00	40
CW013	1.5 - 45 Mtrs	1590.00	40
CW014	2.5 - 45 Mtrs	2550.00	36
CW015	4.0 - 45 Mtrs	3960.00	20

### PVC INSULATED SINGLE CORE - 90 Mtrs FRLS AS PER ISI

Product Code	Conductor Area (Sq mm)	LIST PRICE	MASTER CARTON PACKING (NOS)
CW016	1.0 - 90 Mtrs - FRLS	2120.00	20
CW017	1.5 - 90 Mtrs - FRLS	3210.00	20
CW018	2.5 - 90 Mtrs - FRLS	5130.00	18
CW019	4.0 - 90 Mtrs - FRLS	7940.00	10
CW020	6.0 - 90 Mtrs - FRLS	11705.00	7
CW021	10.0 - 90 Mtrs - FRLS	20400.00	5

\* Maharaja Wires are supplied in 45 Mtrs, 90 Mtrs, 180 Mtrs and also customizable on request on MOQ.

\* Colours - Red, Yellow, Blue, Black, Green, White & Grey.

\*Price List is subject to change without prior notice.

#### Terms & Conditions

\* Material Price are Ex-Factory.

\*Material once sold cannot be returned unless manufactured defects.

\*Manufactured defects will be exchanged or refunded upto the invoice value only.

## Round PVC Round Sheathed, Multicore - 90 Mtrs Annealed Bare Copper.

LP NO : 03/2105/26-27

Product Code	Conductor Area (Sq mm)	LIST PRICE	Product Code	Conductor Area (Sq mm)	LIST PRICE
<b>2 Core</b>			<b>3 Core</b>		
CW022	0.50 Sq mm.	3520.00	CW029	0.50 Sq mm.	4795.00
CW023	0.75 Sq mm.	3860.00	CW030	0.75 Sq mm.	5165.00
CW024	1.00 Sq mm.	4360.00	CW031	1.00 Sq mm.	6400.00
CW025	1.50 Sq mm.	6200.00	CW032	1.50 Sq mm.	8800.00
CW026	2.50 Sq mm.	9375.00	CW033	2.50 Sq mm.	13060.00
CW027	4.00 Sq mm.	15635.00	CW034	4.00 Sq mm.	22150.00
CW028	6.00 Sq mm.	22495.00	CW035	6.00 Sq mm.	33575.00
<b>4 Core</b>					
CW036	1.00 Sq mm.	8745.00			
CW037	1.50 Sq mm.	11200.00			
CW038	2.50 Sq mm.	17470.00			
CW039	4.00 Sq mm.	29900.00			
CW040	6.00 Sq mm.	44640.00			

## Maharaja Twin &amp; Flexible Cables, TV Cable, Speaker Wire.

Product Code	Conductor Area (Sq mm)	TYPE	LIST PRICE
CW041	14/.0048 - 85 Mtrs	SILK WIRE / FLEXIBLE	1030.00
CW042	23/.0048 - 85 Mtrs	SILK WIRE / FLEXIBLE	1335.00
CW043	40/.0048 - 85 Mtrs	SILK WIRE / FLEXIBLE	2160.00
CW044	23/.0048 - 85 Mtrs	TWIN / FLAT WIRE	1590.00
CW045	40/.0044 - 85 Mtrs	TWIN / FLAT WIRE	3110.00
CW046	RG 6 - 90 Mtrs	T.V CABLE	1335.00
CW047W	RG 8 - 90 Mtrs (White)	T.V CABLE	1670.00
CW047	RG 8 - 90 Mtrs	T.V CABLE	1550.00
CW048	RG 6 - 270 Mtrs	T.V CABLE	4225.00
CW049	RG 8 - 270 Mtrs	T.V CABLE	4655.00
CW050	23/SPEAKER WIRE	SPEAKER WIRE	1380.00
CW051	40/SPEAKER WIRE	SPEAKER WIRE	2100.00
CW103	7/20 SOLID	COPPER SOLID	7780.00

## Maharaja Submersible/Flat Cable (3 Core)

Product Code	Conductor Area (Sq mm)	List Price	Units
CW070	2.5 Sq mm	168.00	Per Mtr
CW071	4.0 Sq mm	257.00	Per Mtr
CW072	6.0 Sq mm	378.00	Per Mtr

**Terms & Conditions**

\* Material Price are Ex-Factory.

\*Material once sold cannot be returned unless manufactured defects.

\*Manufactured defects will be exchanged or refunded upto the invoice value only.

## Maharaja Aluminium Wires & Cables

LP NO : 03/2105/26-27

Product Code	Conductor Area (Sq mm)	Units	LIST PRICE
CW052	2.5 Sq mm	Per No	720.00
CW053	4.0 Sq mm	Per No	1015.00
CW054	6.0 Sq mm	Per No	1450.00
CW055	10.0 Sq mm	Per No	2135.00
CW056	6.0 Sq mm (Rolls)	Per Mtr	16.70
CW057	10.0 Sq mm (Rolls)	Per Mtr	24.60

## Zeeflex Aluminium Wires & Cables

Product Code	Conductor Area (Sq mm)	Units	LIST PRICE
CW058	2.5 Sq mm	Per No	500.00
CW059	4.0 Sq mm	Per No	700.00
CW060	6.0 Sq mm	Per No	925.00
CW061	10.0 Sq mm	Per No	1410.00
CW062	12.0 Sq mm	Per No	2135.00
CW063	6.0 Sq mm (Rolls)	Per Mtr	12.00
CW064	10.0 Sq mm (Rolls)	Per Mtr	18.40
CW065	12.0 Sq mm (Rolls)	Per Mtr	27.90
CW066	16.0 Sq mm (Rolls)	Per Mtr	34.50

## Zeeflex Aluminium Wires & Cables (2 Core Flat Cable)

Product Code	Conductor Area (Sq mm)	Units	LIST PRICE
CW067	4.0 x 2 Core (Flat)	Per Mts	22.85
CW068	6.0 x 2 Core (Flat)	Per Mts	29.80
CW069	10.0 x 2 Core (Flat)	Per Mts	43.35
CW102	10.0 x 2 Core (Flat) (MAHARAJA)	Per Mts	60.70

## ACC GOLD STAR Aluminium Wires & Cables

Product Code	Conductor Area (Sq mm)	Units	LIST PRICE
CW096	6.0 Sq mm	Per No	780.00
CW097	10.0 Sq mm	Per No	1180.00
CW098	12.0 Sq mm	Per No	1520.00
CW099	6.0 Sq mm (Rolls)	Per Mts	10.20
CW100	10.0 Sq mm (Rolls)	Per Mts	15.40
CW101	12.0 Sq mm (Rolls)	Per Mts	19.85

## ACC GOLD STAR - 2 CORE (7 STRANDS) Aluminium Wires & Cables

Product Code	Conductor Area (Sq mm)	Units	LIST PRICE
CW104	6.0 x 2 Core (Flat) (7 Strands)	Per Mtr	39.00
CW105	10.0 x 2 Core (Flat) (7 Strands)	Per Mtr	ON REQUEST
CW106	12.0 x 2 Core (Flat) (7 Strands)	Per Mtr	ON REQUEST

### Terms & Conditions

\* Material Price are Ex-Factory.

\*Material once sold cannot be returned unless manufactured defects.

\*Manufactured defects will be exchanged or refunded upto the invoice value only.



# Maharaja Under-Ground Cable (LT Cable)

LP NO : 03/2105/26-27

Product Code	Conductor Area (Sq mm)	LIST PRICE
CW080	6.0 x 4 Core U.G Cable	93 + GST
CW081	10.0 x 2 Core U.G Cable	93 + GST
CW082	10.0 x 4 Core U.G Cable	105 + GST
CW083	16.0 x 4 Core U.G Cable	122 + GST
CW084	25.0 x 3.5 Core U.G Cable	165 + GST
CW085	25.0 x 4 Core U.G Cable	180 + GST
CW086	35.0 x 3.5 Core U.G Cable	200 + GST
CW087	35.0 x 4 Core U.G Cable	212 + GST
CW088	50.0 x 3.5 Core U.G Cable	270 + GST
CW089	50.0 x 4 Core U.G Cable	295 + GST
CW090	70.0 x 3.5 Core U.G Cable	400 + GST
CW091	95.0 x 3.5 Core U.G Cable	500 + GST
CW092	120.0 x 3.5 Core U.G Cable	600 + GST
CW093	10.0 x 2 Core UnArmoured Cable (Round)	39 + GST
CW094	10.0 x 3 Core UnArmoured Cable (Round)	46 + GST
CW095	10.0 x 4 Core UnArmoured Cable (Round)	54 + GST

## Terms & Conditions

\* Material Price are Ex-Factory.

\*Material once sold cannot be returned unless manufactured defects.

\*Manufactured defects will be exchanged or refunded upto the invoice value only.

# **SWITCH AND ACCESSORIES DISCOUNTS**

**101 : 15 rs incl gst**

**111 : 17 rs incl gst**

**3106 : 19 rs incl gst**

**116 : 22 rs incl gst**

**519 : 16 rs incl gst**

**509 & 510 : 24rs incl gst**

**604 : 115 incl gst**

**3604 : 230 incl gst**

**801 & 806: 20rs incl gst**

**861 : 23 rs incl gst**

**801 G & 806 G : 23 rs incl gst**

**861 G : 26 rs incl gst**

**610 new price 175 rs. incl gst**

**611 AND 611A new price 230 incl gst**

**505 6A top, 506 16A top, 501 SP AND 502 DP MCB BOX, 609 DD BELL : 52% incl gst**

**Metalbox db box : 58% incl gst**

**Gangbox : 50% incl gst**

**Rest Off 56% incl gst**

**Applicable from 21/05/2026**



“  
TRANSFORMING  
SPACES,  
ONE SWITCH  
AT A TIME”

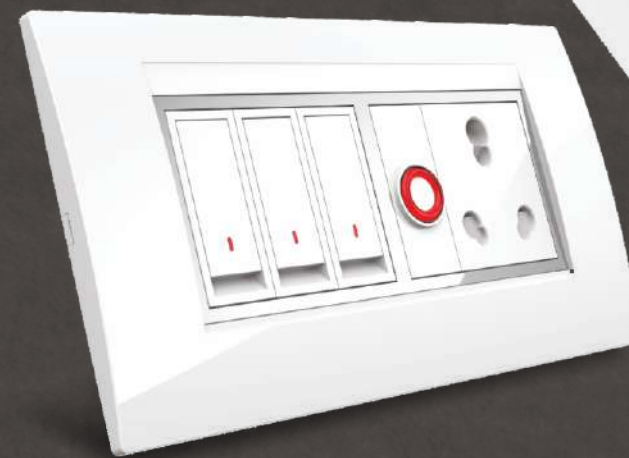

Term & Conditions

- Price are subject to change without prior Notice.
  - All the prices are inclusive of taxes.
  - Prices in the list are for one unit.
  - All Items will be supplied in standard packing only.
- # Due to printing limitation, colour printed may not be exact and same.

**PRO-LINE INDUSTRIES**

Kamakshipalya, Bangalore - 560079

 [www.maharajawires.com](http://www.maharajawires.com)

For Sales enquiry mail us at  
[sales@maharajawires.com](mailto:sales@maharajawires.com)

Ph no : + 91 9108414106

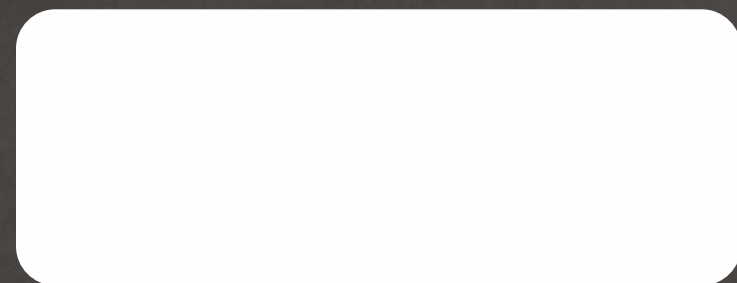

**DECEMBER 2025**

PRODUCTS AND PRICING  
MANUAL





# ABOUT US

At Maharaja, we're passionate about powering a brighter future with our high-quality electrical solutions. Since 1995, we've been manufacturing top-notch wires, cables, modular switch boards, and LED products that meet the highest standards of safety, durability, and performance. Our team of experts is dedicated to delivering innovative solutions that cater to the evolving needs of electricians, architects, and homeowners. With a strong focus on customer satisfaction, we've built a reputation as a trusted partner in the electrical industry.

**Give Your interior  
a classic impression**

# OUR VISION

At MAHARAJA, we believe in setting high standards for the industry to make life safer, simpler and convenient for everyone. We strive hard to give the best user experience and services to all our customers.



101 102 103 104 105

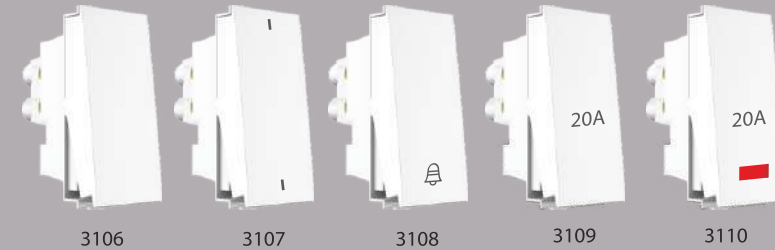

3106 3107 3108 3109 3110



111 112 113 114 115



116 117 118 119 154

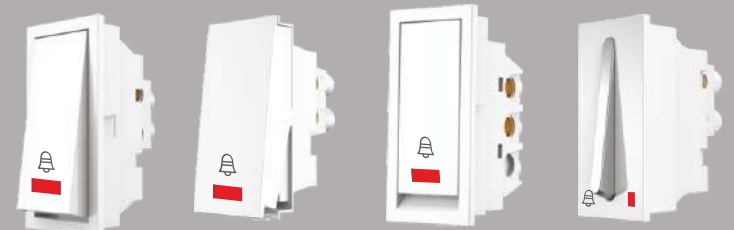

145 146 147 155

CODE	PRODUCT	M.R.P	QTY	HSN CODE
------	---------	-------	-----	----------

**SOFT SERIES**

101	10A 1 WAY SWITCH	63	20	85365020
102	10A 2 WAY SWITCH	75	20	85365020
103	10A BELL PUSH	75	20	85365020
104	20A 1 WAY SWITCH	84	20	85365020
105	20A 1 WAY SWITCH WITH INDICATOR	100	20	85365020

**SUMO SWITCH**

3106	10A 1 WAY SWITCH	75	20	85365020
3107	10A 2 WAY SWITCH	90	20	85365020
3108	10A BELL PUSH	90	20	85365020
3109	20A 1 WAY SWITCH	99	20	85365020
3110	20A 1 WAY SWITCH WITH INDICATOR	118	20	85365020

**FLAT SERIES**

111	10A 1 WAY SWITCH	68	20	85365020
112	10A 2 WAY SWITCH	80	20	85365020
113	10A BELL PUSH	80	20	85365020
114	20A 1 WAY SWITCH	89	20	85365020
115	20A 1 WAY SWITCH WITH INDICATOR	108	20	85365020

**SLIM SERIES**

116	10A 1 WAY SWITCH	80	20	85365020
117	10A 2 WAY SWITCH	100	20	85365020
118	10A BELL PUSH	100	20	85365020
119	20A 1 WAY SWITCH	109	20	85365020
154	20A 1 WAY SWITCH WITH INDICATOR	130	20	85365020

**BELLPUSH WITH IND. SWITCHES - 1M**

145	10A BELL PUSH WITH INDICATOR - SOFT	84	20	85365020
146	10A BELL PUSH WITH INDICATOR - SUMO	95	20	85365020
147	10A BELL PUSH WITH INDICATOR - FLAT	89	20	85365020
155	10A BELL PUSH WITH INDICATOR - SLIM	114	20	85365020

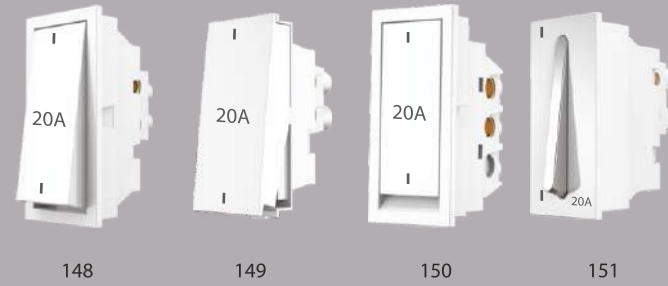

CODE	PRODUCT	M.R.P	QTY	HSN CODE
<b>20A 2WAY SWITCH - 1M</b>				
148	20A 2 WAY SWITCH - SOFT	103	20	85365020
149	20A 2 WAY SWITCH - SUMO	113	20	85365020
150	20A 2 WAY SWITCH - FLAT	108	20	85365020
151	20A 2 WAY SWITCH - SLIM	136	20	85365020

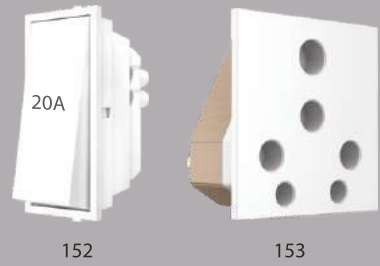

<b>SWITCH AND SOCKET (UREA)</b>				
152	20A SWITCH UREA	150	10	85365020
153	16A SOCKET UREA	156	10	85366910

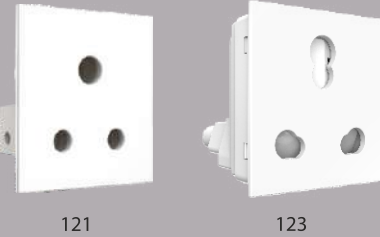

<b>SOCKETS</b>				
121	3 PIN SOCKET	62	10	85366910
123	6A/16A SOCKET WITH SHUTTER	142	10	85366910



<b>REGULATORS</b>				
125	4 STEP REGULATOR (1M)	271	20	84149030
126	5 STEP REGULATOR (2M)	322	10	84149030



<b>MODULAR ACCESSORIES</b>				
127	T.V SOCKET	84	10	85366910
128	TELEPHONE JACK	89	10	85367000
129	KITKAT	103	10	85362030
130	1M USB	518	10	85362030
156	1M USB TYPE C AND A	663	10	85362030
131	INDICATOR	65	20	85318000
131A	RING INDICATOR	71	20	85318000
132	BLANK (DUMMY)	7	100	85389000

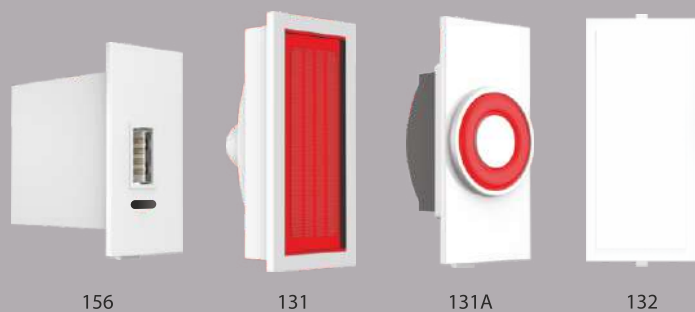

CODE	PRODUCT	M.R.P	QTY	HSN CODE
<b>2M SWITCHES (SOFT SERIES)</b>				
133	32A DP SWITCH	256	10	85365020
134	10A 2M BELL SWITCH WITH INDICATOR	114	10	85365020
135	20A 2M SWITCH WITH INDICATOR	135	10	85365020



<b>2M SWITCHES (FLAT SERIES)</b>				
136	32A DP SWITCH	261	10	85365020
137	10A 2M BELL SWITCH WITH INDICATOR	120	10	85365020
138	20A 2M SWITCH WITH INDICATOR	141	10	85365020



<b>2M SWITCHES (SUMO)</b>				
157	32A DP SWITCH	292	10	85365020
158	10A 2M BELL SWITCH WITH INDICATOR	137	10	85365020
159	20A 2M SWITCH WITH INDICATOR	160	10	85365020



<b>LED FOOT LIGHTS</b>				
139	1M LED FOOT LAMP	206	10	94051090
140	2M LED FOOT LAMP	232	10	94051090
141	3M LED FOOT LAMP	258	10	94051090
142	4M LED FOOT LAMP WITH PLATE	394	10	94051090

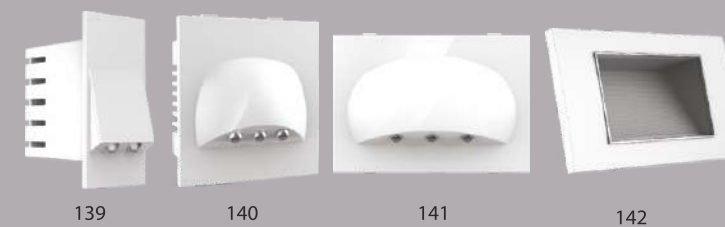

<b>MODULAR MCB</b>				
143	6A TO 32A S.P MCB	206	10	85362030
144	6A TO 32A D.P MCB	456	10	85362030



# GREAT INNOVATIONS DESERVE A GRAND STAGE



*Exquisite  
Beauty*

Starting out as a small family business MAHARAJA SWITCHES - has grown to a company now employing a team of skilled professionals. We took over the family business and through our leadership and experience, we developed many strong and lasting relationships with our channel partners & consumers.





**ECO PLUS  
METAL BOX PLATES**

THERE IS BEAUTY IN  
**SIMPLICITY**



**LEXA**  
METAL BOX PLATES

A STEP TOWARDS  
**PERFECTION**

ECO PLUS - METAL BOX PLATES										
<b>CODE</b>	3201	3202	3203	3204	3205	3206	3207	3208	3209	3210
<b>PRODUCT</b>	1M	2M	3M	4M	6M	8MSQ	8MHZ	12M	16M	18M
<b>M.R.P</b>	69	69	89	100	154	206	206	249	309	318
<b>QTY</b>	10	10	10	10	10	10	10	10	10	10
<b>HSN CODE</b>	85389000 & GST 18% (Same For All Module) M.R.P Inclusive of GST									

LEXA- METAL BOX PLATES										
<b>CODE</b>	401	402	403	404	405	406	407	408	409	4110
<b>PRODUCT</b>	1M	2M	3M	4M	6M	8MSQ	8MHZ	12M	16M	18M
<b>M.R.P</b>	69	69	89	100	154	206	206	249	309	318
<b>QTY</b>	10	10	10	10	10	10	10	10	10	10
<b>HSN CODE</b>	85389000 & GST 18% (Same For All Module) M.R.P Inclusive of GST									

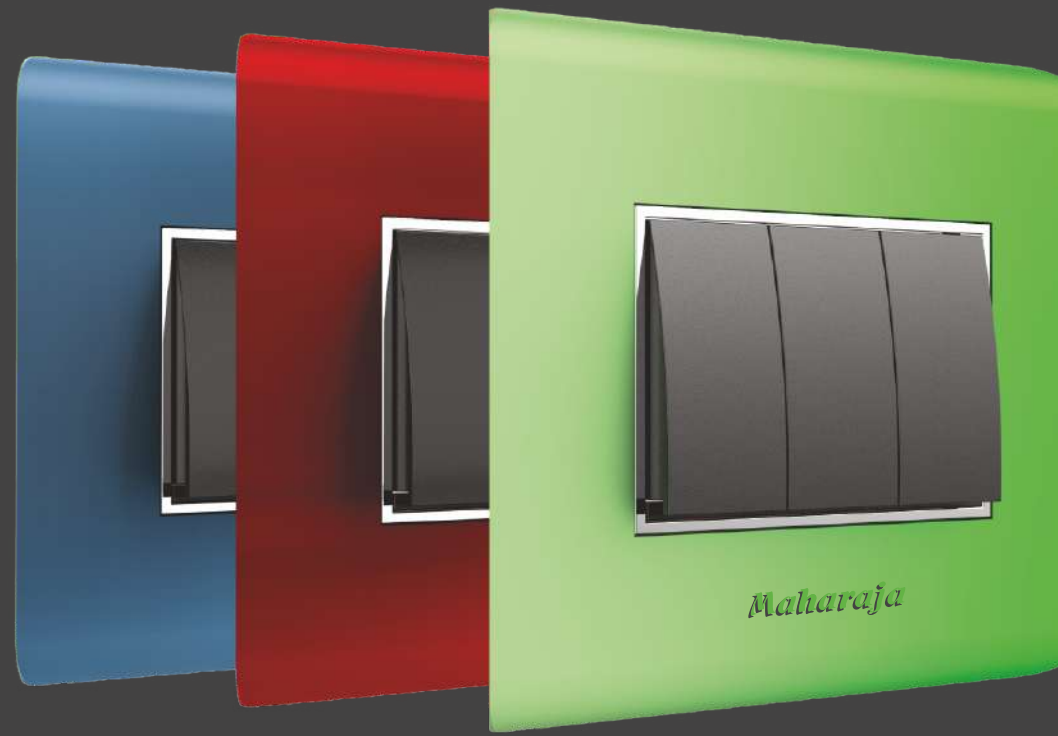

# SLIM

WOODEN & METAL BOX PLATES



# BOLD

WOODEN & METAL BOX PLATES

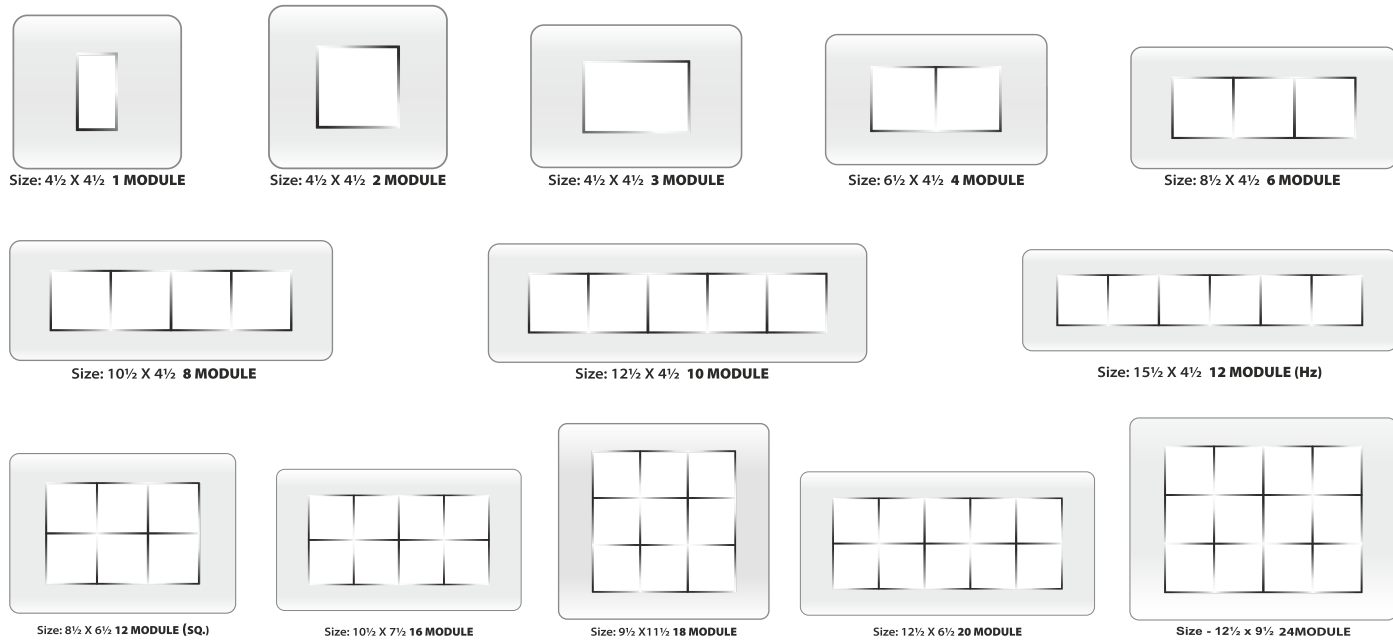

### SLIM - WOODEN & METAL BOX PLATES

CODE	3211	3212	3213	3214	3215	3216	3217	3218	3219	3220	3221	3222	3223
PRODUCT	1M	2M	3M	4M	6M	8M	10M	12M SQ	12M HZ	16M	18M	20M	24M
M.R.P	101	101	106	133	172	218	240	273	328	350	434	450	478
QTY	10	10	10	10	10	10	10	10	10	10	10	10	5

HSN CODE 85389000 & GST 18% (Same For All Module) M.R.P Inclusive of GST



### BOLD - WOODEN & METAL BOX PLATES

CODE	311	312	313	314	315	316	317	318	319	320	321	322	323	324
PRODUCT	1M	2M	3M	4M	6M	8M	10M	12M SQ	12M HZ	16M	18M V	18M SQ	20M	24M
M.R.P	101	101	106	133	172	218	240	273	328	350	434	434	450	478
QTY	10	10	10	10	10	10	10	10	10	10	10	10	10	5

HSN CODE 85389000 & GST 18% (Same For All Module) M.R.P Inclusive of GST



## SURFACE BOX



3301

3302

3303



3304

3305

3306

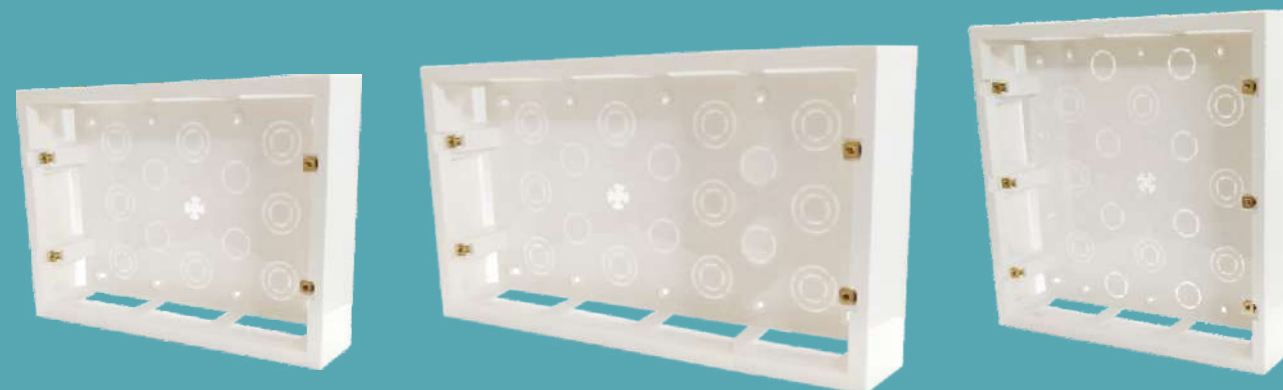

3307

3308

3309

### SURFACE BOX

CODE	3301	3302	3303	3304	3305	3306	3307	3308	3309
PRODUCT	1&2M	3M	4M	6M	8MSQ	8MHZ	12M	16M	18M
M.R.P	88	109	124	158	192	192	231	292	302
QTY	20	10	10	10	5	10	5	5	5
HSN CODE	85389000 & GST 18% (Same For All Module) M.R.P Inclusive of GST								



**GIVING YOUR  
HOME A  
NEW STYLE  
EVERY STYLE**

GANGBOX



### GANGBOX

CODE	410	411	412	413	414	415	416	420	417	418	419
PRODUCT	1M	2M	3M	4M	6M	8MSQ	8MHZ	9M	12M	16M	18M
M.R.P	65	83	97	109	155	180	180	220	232	335	361
QTY	20	20	10	10	10	10	10	10	5	5	5
HSN CODE	85389000 & GST 18% (Same For All Module) M.R.P Inclusive of GST										

CODE	PRODUCT	M.R.P	QTY	HSN CODE
------	---------	-------	-----	----------

**MCB BOXES**

501	1 AND 2 POLE MCB BOX	70	10	85371000
502	3 AND 4 POLE MCB BOX	102	5	85371000



**TOPS**

503	2 PIN TOP	26	40	85366910
504	MALE/FEMALE	46	24	85366910
505	6A 3 PIN TOP	78	20	85366910
506	16A 3 PIN TOP	125	10	85366910

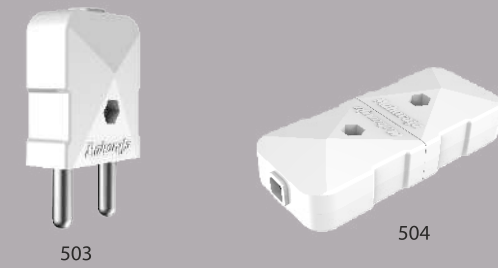

**DLX HOLDER**

507	DLX ANGLE HOLDER	47	20	85366110
508	DLX BATTEN HOLDER	47	20	85366110



**SUMO HOLDER**

509	SUMO ANGLE HOLDER	57	20	85366110
510	SUMO BATTEN HOLDER	57	20	85366110

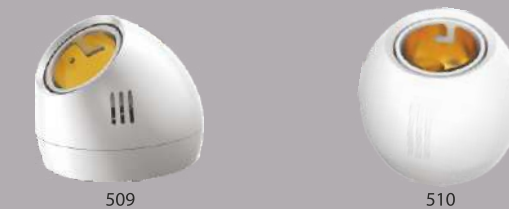

**4X4 HOLDER**

3509	4X4 ANGLE HOLDER	100	10	85366110
3510	4X4 BATTEN HOLDER	100	10	85366110

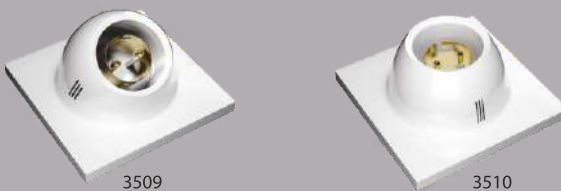

CODE	PRODUCT	M.R.P	QTY	HSN CODE
------	---------	-------	-----	----------

**ROUND PLATES**

511	ROUND PLATE	12	50	85389000
512	FAN ROUND PLATE	15	50	85389000



**CEILING ROSE**

513	PILOT CEILING ROSE	46	25	85366110
514	JUMBO CEILING ROSE	58	20	85366110

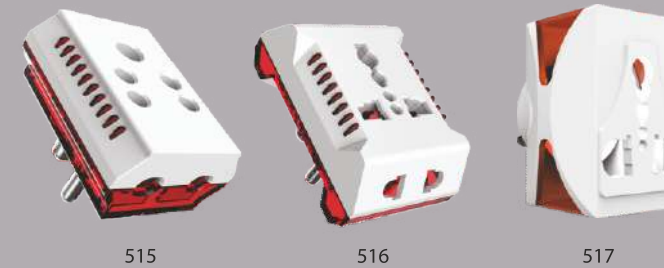

**MULTI PLUG**

515	6A MULTI PLUG	96	20	85366910
516	13A MULTI PLUG	112	20	85366910
517	6A TO 16A 3 PIN MULTI PLUG	182	10	85366910
518	6A TO 16A CONVERTOR	105	20	85366910
525	6A TO 16A 2 PIN MULTI PLUG	162	10	85366910
526	TRAVEL ADAPTOR	191	10	85366910



**HANGING ACCESSORIES**

519	PENDENT HOLDER	38	36	85366110
520	BED SWITCH	44	20	85365020
521	ADAPTORS	40	20	85365020



**MULTI HOLDERS**

522	BC PARALELL HOLDER	51	30	85365020
523	2 PIN PARALELL HOLDER	63	30	85365020
524	MULTI PENDENT HOLDER	57	36	85365020



**FLEXBOX AND POWERSTRIP**

601	2 PIN FLEXBOX (4 METER)	550	5	85371000
601A	3 PIN FLEXBOX (4 METER)	625	5	85371000
602	POWERSTRIP (1.5 METER)	657	5	85371000
603	POWERSTRIP (5 METER)	867	5	85371000

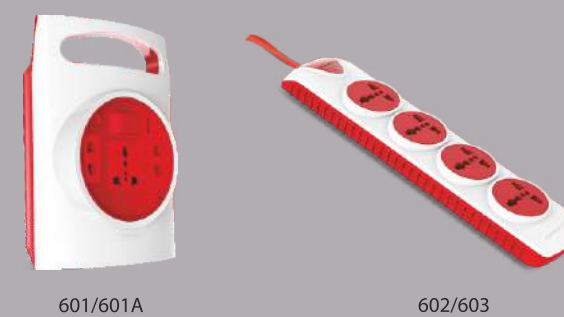

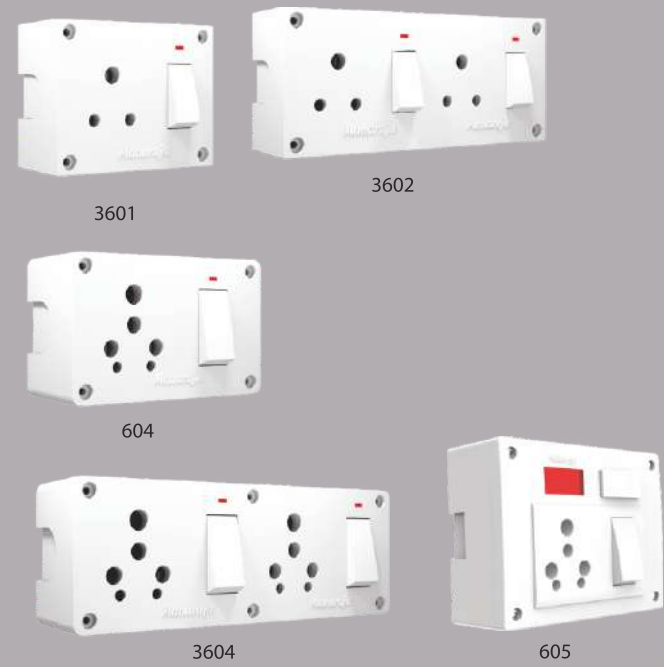

CODE	PRODUCT	M.R.P	QTY	HSN CODE
<b>SWITCH SOCKET COMBINE</b>				
3601	6A S.S COMBINE WITH BOX	165	10	85371000
3602	6A SS COMBINE DOUBLE WITH BOX	309	10	85371000
604	6A/16A S.S COMBINE WITH BOX	262	10	85371000
3604	6A/16A SS COMBINE DOUBLE WITH BOX	523	10	85371000
605	5 IN 1 SS COMBINE	413	5	85371000



CODE	PRODUCT	M.R.P	QTY	HSN CODE
<b>32A DP</b>				
606	32A OPEN TYPE DP	270	5	85365020
607	32A CONCEALED DP	270	5	85365020
608	32A OPEN TYPE DP MCB	550	5	85365020



CODE	PRODUCT	M.R.P	QTY	HSN CODE
<b>DOOR BELL</b>				
609	DING DONG BELL	263	10	85318000
610	PARROT BELL	319	10	85318000
611	MUSICAL BELL	505	5	85318000
611A	Gayatri Mantra Bell	505	5	85318000

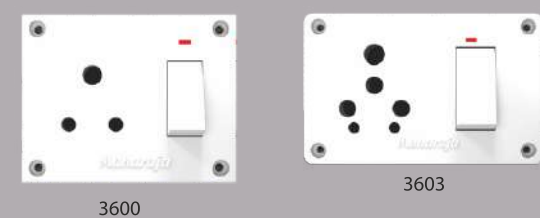

CODE	PRODUCT	M.R.P	QTY	HSN CODE
<b>SWITCH SOCKET COMBINE</b>				
3600	6A S.S COMBINE	130	10	85371000
3603	6A/16A S.S COMBINE	225	10	85371000

## POWER SPLIT



CODE	PRODUCT	M.R.P	QTY	HSN CODE
<b>POWER SPLIT</b>				
623	6A 2+2 Power Split - 1.5 Mtrs.	500	1	85371000
624	6A 2+2 Power Split - 5 Mtrs.	650	1	85371000
625	6A 3+3 Power Split - 1.5 Mtrs.	750	1	85371000
626	6A 3+3 Power Split - 5 Mtrs.	900	1	85371000
627	16A 2+2 Power Split - 2 Mtrs.	750	1	85371000
628	16A 2+2 Power Split - 5 Mtrs.	1000	1	85371000
629	16A 3+3 Power Split - 2 Mtrs.	1375	1	85371000
630	16A 3+3 Power Split - 5 Mtrs.	1625	1	85371000

## DISTRIBUTION BOX (DB BOX)



3621 to 3636

CODE	PRODUCT	M.R.P	QTY	HSN CODE
<b>DISTRIBUTION BOX (DB BOX) SPN DOUBLE DOOR</b>				
3621	4 WAY DB BOX	1042	1	85371000
3622	6 WAY DB BOX	1177	1	85371000
3623	8 WAY DB BOX	1382	1	85371000
3624	10 WAY DB BOX	1585	1	85371000
3625	12 WAY DB BOX	1674	1	85371000
3626	16 WAY DB BOX	2055	1	85371000

## METALBOX



612 to 620

CODE	PRODUCT	M.R.P	QTY	HSN CODE
<b>METALBOX (20GAUGE)</b>				
612	1-2M	89	20	85389000
613	3M	108	20	85389000
614	4M	130	10	85389000
615	6M	183	10	85389000
616	8M SQ	218	10	85389000
617	8M HZ	218	10	85389000
618	12M	274	5	85389000
619	16M	340	5	85389000
620	18M	386	5	85389000



CODE	PRODUCT	M.R.P	QTY	HSN CODE
<b>MCB</b>				
701	06A SP MCB	193	12	85362030
702	10A SP MCB	193	12	85362030
703	16A SP MCB	193	12	85362030
704	20A SP MCB	193	12	85362030
705	25A SP MCB	193	12	85362030
706	32A SP MCB	193	12	85362030
707	40A SP MCB	330	12	85362030
708	63A SP MCB	438	12	85362030
709	06A DP/SPN MCB	469	6	85362030
710	10A DP/SPN MCB	469	6	85362030
711	16A DP/SPN MCB	469	6	85362030
712	20A DP/SPN MCB	469	6	85362030
713	25A DP/SPN MCB	469	6	85362030
714	32A DP/SPN MCB	469	6	85362030
715	40A DP/SPN MCB	685	6	85362030
716	63A DP/SPN MCB	800	6	85362030
719	06A TP MCB	786	4	85362030
720	10A TP MCB	786	4	85362030
721	16A TP MCB	786	4	85362030
722	20A TP MCB	786	4	85362030
723	25A TP MCB	786	4	85362030
724	32A TP MCB	786	4	85362030
725	40A TP MCB	961	4	85362030
726	63A TP MCB	1100	4	85362030
727	6A FP / TPN MCB	1063	3	85362030
728	10A FP/TPN MCB	1063	3	85362030
729	16A FP/TPN MCB	1063	3	85362030
730	20A FP/TPN MCB	1063	3	85362030
731	25A FP/TPN MCB	1063	3	85362030
732	32A FP/TPN MCB	1063	3	85362030
733	40A FP/TPN MCB	1263	3	85362030
734	63A FP/TPN MCB	1543	3	85362030

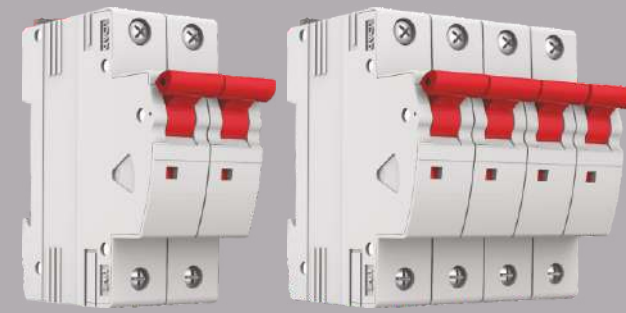

621

622

CODE	PRODUCT	M.R.P	QTY	HSN CODE
<b>ISOLATORS</b>				
717	40A DP ISOLATOR	383	6	85362090
718	63A DP ISOLATOR	453	6	85362090
735	40A FP ISOLATOR	818	3	85362090
736	63A FP ISOLATOR	850	3	85362090
<b>CHANGE OVER</b>				
737	25A DP CHANGE OVER	834	6	85362030
738	40A DP CHANGE OVER	944	6	85362030
739	63A DP CHANGE OVER	1021	6	85362030
740	25A FP CHANGE OVER	1570	3	85362030
741	40A FP CHANGE OVER	1691	3	85362030
742	63A FP CHANGE OVER	1789	3	85362030
<b>RCCB</b>				
743	40A DP RCCB 30 MA	2018	6	85362030
744	40A DP RCCB 100 MA	2018	6	85362030
745	63A DP RCCB 30 MA	2365	6	85362030
746	63A DP RCCB 100 MA	2365	6	85362030
747	40A FP RCCB 30 MA	2425	3	85362030
748	40A FP RCCB 100 MA	2425	3	85362030
749	63A FP RCCB 30 MA	2837	3	85362030
750	63A FP RCCB 100 MA	2837	3	85362030
<b>MCB METALBOX</b>				
621	1/2 WAY BOX	194	1	85371000
622	3/4 WAY BOX	274	1	85371000



# **EXPAND** YOUR **IMAGINATION**

*MAHARAJA offers a range of premium category switches & accessories that underlines contemporary style.*

*Take your interior design's elegance up by a few notches with the highly aesthetic*



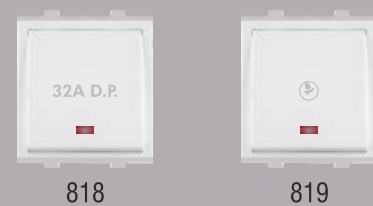
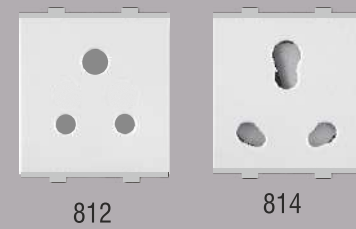

CODE	PRODUCT	M.R.P ₹		QTY	HSN CODE
		White	Grey		
<b>PRIME SWITCH SERIES</b>					
801	10A 1 WAY SWITCH	88	101	20	85365020
802	10A 2 WAY SWITCH	105	120	20	85365020
803	10A BELL PUSH SWITCH	105	120	20	85365020
804	20A 1 WAY SWITCH	117	135	20	85365020
805	20A 1 WAY SWITCH WITH IND.	141	162	20	85365020

<b>MIGHTY SWITCH SERIES</b>					
806	10A 1 WAY SWITCH	88	101	20	85365020
807	10A 2 WAY SWITCH	105	120	20	85365020
808	10A BELL PUSH SWITCH	105	120	20	85365020
809	20A 1 WAY SWITCH	117	135	20	85365020
810	20A 1 WAY SWITCH WITH IND.	141	162	20	85365020

<b>PIXEL SWITCH SERIES</b>					
861	10A 1 WAY SWITCH	99	114	20	85365020
862	10A 2 WAY SWITCH	117	135	20	85365020
863	10A BELL PUSH SWITCH	117	135	20	85365020
864	20A 1 WAY SWITCH	131	151	20	85365020
865	20A 1 WAY SWITCH WITH IND.	157	181	20	85365020

<b>SOCKETS</b>					
812	3 PIN SOCKET	87	99	10	85366910
814	6A/16A SOCKET	199	229	10	85366910

<b>REGULATORS</b>					
816	4 STEP REGULATOR	352	405	10	84149030
817	5 STEP REGULATOR	419	482	10	84149030

<b>2M SWITCH</b>					
818	32A DP SWITCH	333	383	10	85365020
819	10A 2M BELL PUSH SWITCH	160	184	10	85365020

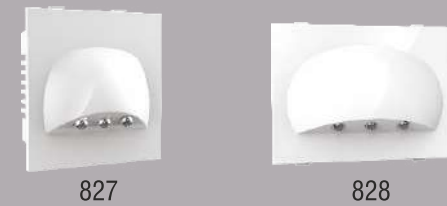
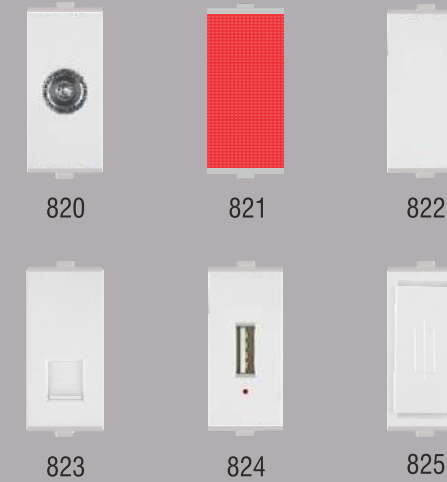

CODE	PRODUCT	M.R.P ₹		QTY	HSN CODE
		White	Grey		
<b>MODULAR ACCESSORIES</b>					
820	TV SOCKET	118	135	10	85366910
821	INDICATOR	84	97	10	85318000
822	BLANK	9	10	40	85389000
823	TELEPHONE JACK	125	144	10	85367000
824	1M USB	673	774	10	85362030
825	KITKAT	144	166	10	85362030

<b>FOOT LAMPS</b>					
827	2M	301	346	10	94051090
828	3M	335	385	10	94051090

<b>MODULAR MCB AND STARTERS</b>					
831	6A - 32A SP MODULAR MCB	268	308	10	85362030
832	6A - 32A DP MODULAR MCB	592	681	10	85362030
833	MOTOR STARTER	483	555	10	85369010



**The Solution  
That You  
Have Dreamed**



**xplore  
your true  
style**

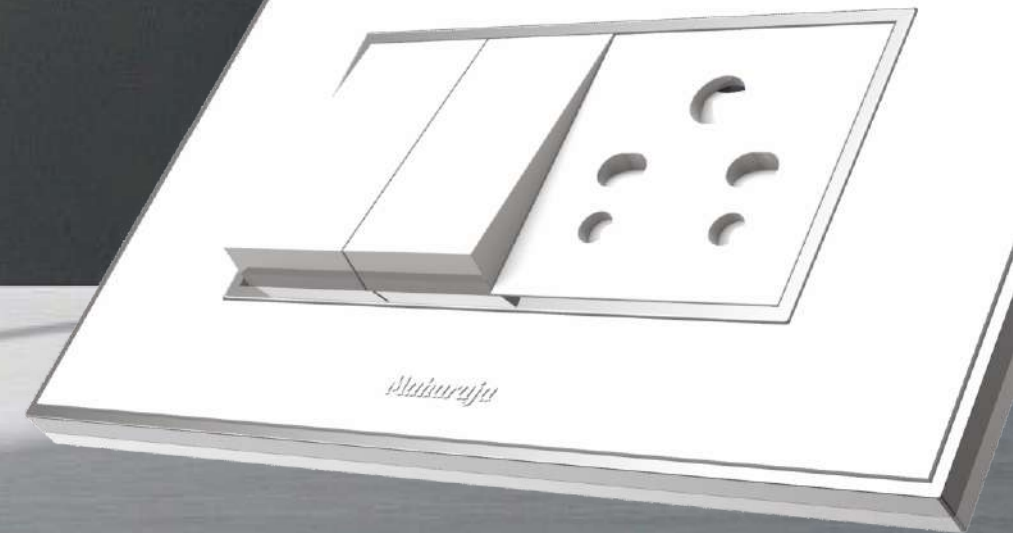
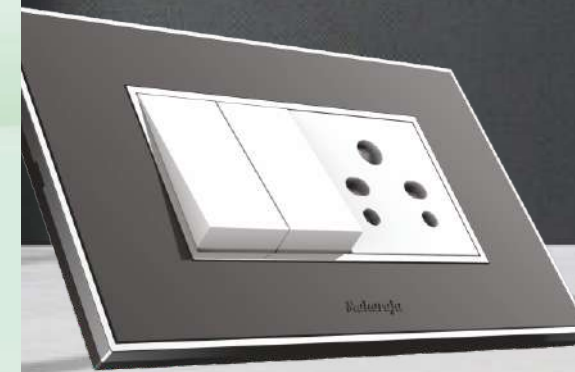

Especially (but not only) when it comes to small spaces - which are getting smaller and smaller - attention to the choice of each piece of furniture is paramount. For this reason, in many cases, it is often more effective to design unique items to make the most efficient use of each square centimeter.

**METAL BOX PLATE SQUARE**

MODULES	1M	2M	3M	4M	6M	8M(Sq.)	8M(Hz.)	12M	16M	18M
CODE	841	842	843	844	845	846	847	848	849	850
WHITE M.R.P.	90	90	116	135	200	267	267	323	402	413
GREY M.R.P.	135	135	174	203	300	401	401	485	603	620
WOOD M.R.P.	180	180	232	270	400	535	535	646	804	827
Pkg.Qty.	10	10	10	10	10	10	10	10	10	10

**METAL BOX PLATE CHROME**

MODULES	1M	2M	3M	4M	6M	8M(Sq.)	8M(Hz.)	12M	16M	18M
CODE	851	852	853	854	855	856	857	858	859	860
WHITE M.R.P.	187	187	203	243	356	426	426	487	533	616
GREY M.R.P.	280	280	304	365	533	639	639	730	799	925
Texture M.R.P.	373	373	405	487	711	852	852	973	1066	1233
Pkg.Qty.	10	10	10	10	10	10	10	10	10	10

HSN Code 85389000 & M.R.P Inclusive of GST 18% (For All Products)

## LED – DISCOUNTS

932: 9-watt bulb - 32rs INC GST

939: 20-watt batten - 95rs INC GST

1000: NEW MOSQUITO RACKET

PRICE 300rs incl GST

Rest Of: 56% INCL GST

Applicable from 10/04/2026

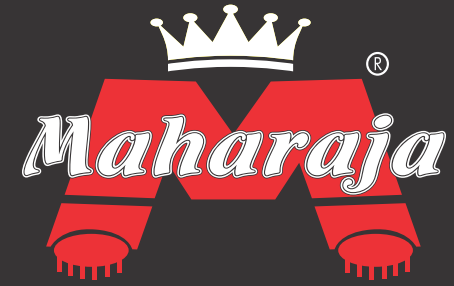

Brilliant  
lights  
for brilliant  
lives.

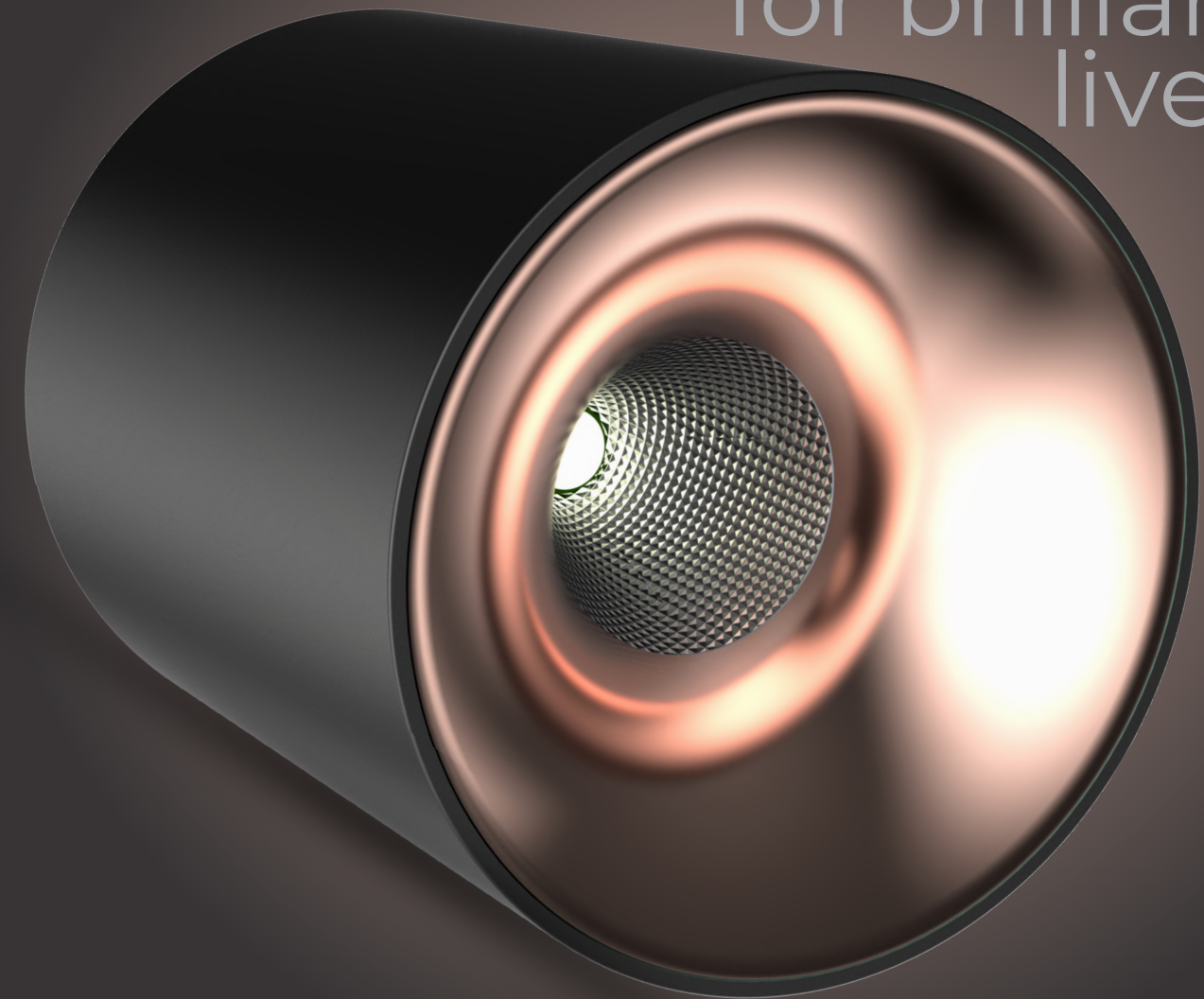

Commercial Terms & Conditions

• Prices are in Indian Rupees (Inclusive of GST) • Prices of all LED products in this price list are of our standard products. • Warranty applicable on the products are as per Maharaja Electrical Pvt Ltd warranty policy. • Prices are subject to change without prior notice. • This Price list supersedes all previous price lists. • Order should be placed in multiples of Master carton. • Continuous design and product development is a routine practice at Maharaja Electrical so data provided may change without any prior information; customers are advised to check the current data and before purchase from the local offices. • Prices given in the list are for one unit.

HI-GRID INDUS TRIES LLP

Bengaluru,  
Karnataka, 560039

✉ [maharajaswitches@gmail.com](mailto:maharajaswitches@gmail.com)

🌐 [www.maharajawires.com](http://www.maharajawires.com)

for sales enquiry

mail us at [sales@maharajawires.com](mailto:sales@maharajawires.com)

Phone :- +91 9108414106

🌐 [www.maharajawires.com](http://www.maharajawires.com)

**2026-27**

LIGHTING CATALOGUE

# Innovative Sustainable Lighting Solution

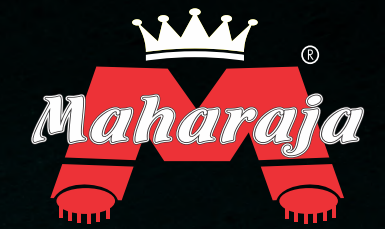

Designed with durable high grade aluminium housings, Completely water sealed, these lights can out-perform in any weather conditions. Good thermal management ensures stable working of LED and effective energy consumption.

## VISION

Purchase high-quality raw material. to provide customers with high quality products & enhance the core competitiveness. Abide by business ethics, to ensure stakeholders (employees,dealers,customers)wealth maximization.

## PURPOSE

To provide high-quality products, to create a low-carbon & friendly lighting environment & represent a healthy environment to customers ; Work fully together to do the excellent product and establish an innovation company ; To establish a harmonious & permanent relationship with the stakeholders.



**Be bright.  
Be safe. Be LED**



WHAT A BRIGHT IDEA



CODE	PRODUCT	COLOR	SHAPE	CUT-OUT	DIMENSIONS	WARRANTY	MRP (₹)	PKG (UNITS)
------	---------	-------	-------	---------	------------	----------	---------	-------------

**H SERIES PANAL**

901	10WATT	W.W, C.W, N.W	R & S	4 INCH	4.5 X 1.5 INCH	2 YEARS	363.00	20
902	15WATT	W.W, C.W, N.W	R & S	5 INCH	5.5 X 1.5 INCH	2 YEARS	555.00	20
903	20WATT	W.W, C.W, N.W	R & S	6 INCH	6.5 X 1.5 INCH	2 YEARS	759.00	20



**S SERIES 3 IN 1 PANEL**

904	8 WATT	W.W + C.W + N.W	R & S	4 INCH	4.5 X 1.5 INCH	2 YEARS	434.00	20
905	15 WATT	W.W + C.W + N.W	R & S	6 INCH	6.5 X 1.5 INCH	2 YEARS	741.00	20



**DEEP DOWNLIGHT PANEL**

906	12WATT	C.W	ROUND	108 MM	118 X 51 MM	2 YEARS	527.00	20
907	18WATT	C.W	ROUND	142 MM	152 X 56 MM	2 YEARS	755.00	20

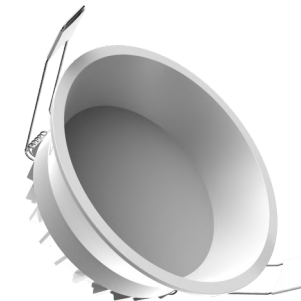

**PROFILE PANAL**

908	15WATT	W.W, C.W, N.W	R & S	6 INCH	6.5 X 1.25 INCH	2 YEARS	661.00	40
-----	--------	---------------	-------	--------	-----------------	---------	--------	----



**H SERIES SURFACE PANEL**

909	10WATT	W.W, C.W, N.W	R & S	----	4.5 X 1.5 INCH	2 YEARS	458.00	20
910	15WATT	W.W, C.W, N.W	R & S	----	5.5 X 1.5 INCH	2 YEARS	702.00	20
911	20WATT	W.W, C.W, N.W	R & S	----	6.5 X 1.5 INCH	2 YEARS	892.00	20





**LONG-LASTING LIGHTS,  
TO MAKE YOUR  
FUTURE BRIGHT**

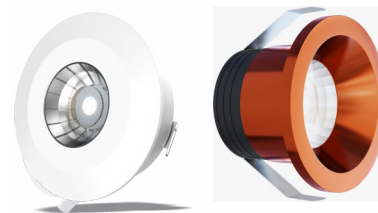
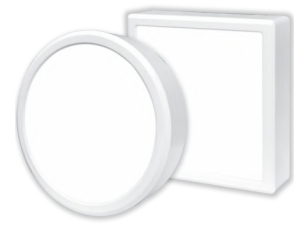
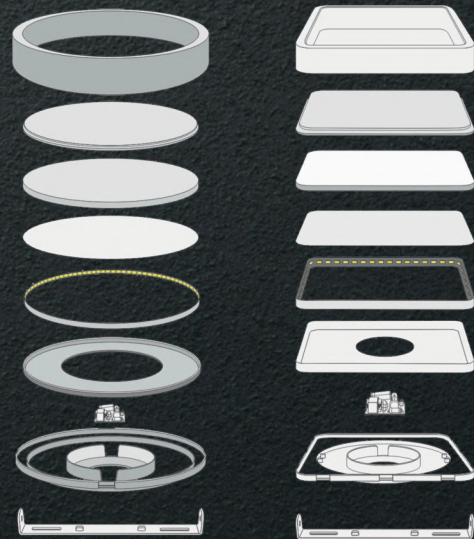

CODE	PRODUCT	COLOR	SHAPE	CUT-OUT	DIMENSIONS	WARRANTY	MRP (₹)	PKG (UNITS)
------	---------	-------	-------	---------	------------	----------	---------	-------------

**S SERIES SURFACE 3 IN 1 PANLE**

912	8 WATT	W.W + C.W + N.W	R & S	---	4.5 X 1.5 INCH	2 YEARS	526.00	20
913	15 WATT	W.W + C.W + N.W	R & S	---	6.5 X 1.5 INCH	2 YEARS	873.00	20

**MOVEABLE COB**

914	3WATT	W.W, C.W, N.W	---	55 MM	70 X 37 MM	2 YEARS	201.00	100
915	6WATT	W.W, C.W, N.W	---	72 MM	105 X 58 MM	2 YEARS	412.00	20

**SPOT LIGHT**

916	2WATT	W.W, C.W, N.W, RED, GREEN, BLUE, PINK	—	33 MM	41 X 15 MM	2 YEARS	106.00	50
979	3WATT ALU SPOT FANCY	W.W, C.W,	—	33 MM	41 X 15 MM	2 YEARS	297.00	50
917	4WATT MOVABLE SPOT LIGHT	W.W, C.W, N.W, RED, GREEN, BLUE, PINK	—	65MM	74 X 41 MM	2 YEARS	202.00	100
918	7 WATT MOVABLE SPOT LIGHT	W.W, C.W, N.W	—	75 MM	105 X 45 MM	2 YEARS	300.00	50
919	12WATT MOVABLE SPOT LIGHT	W.W, C.W, N.W	—	100 MM	128 X 53 MM	2 YEARS	568.00	20



**WHAT A BRIGHT IDEA**

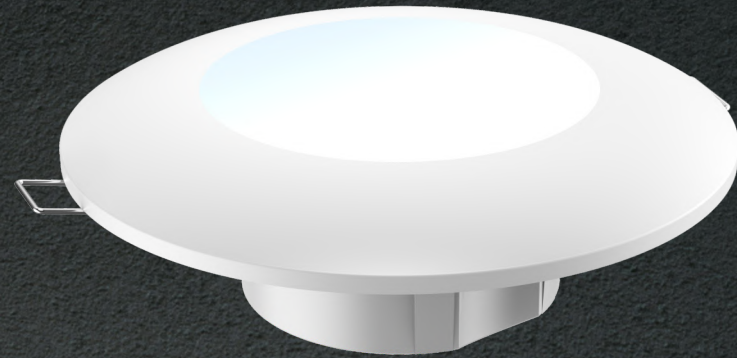

“GLOW THAT GOES FURTHER.”

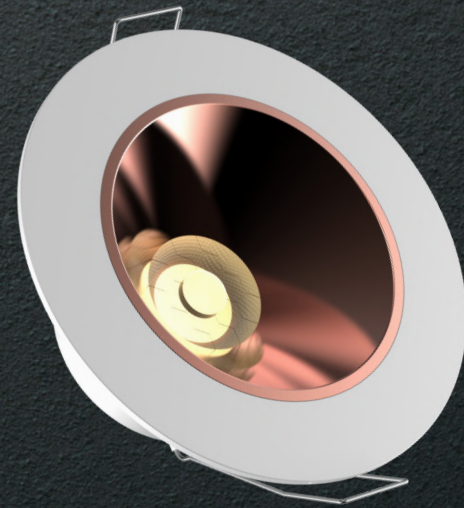
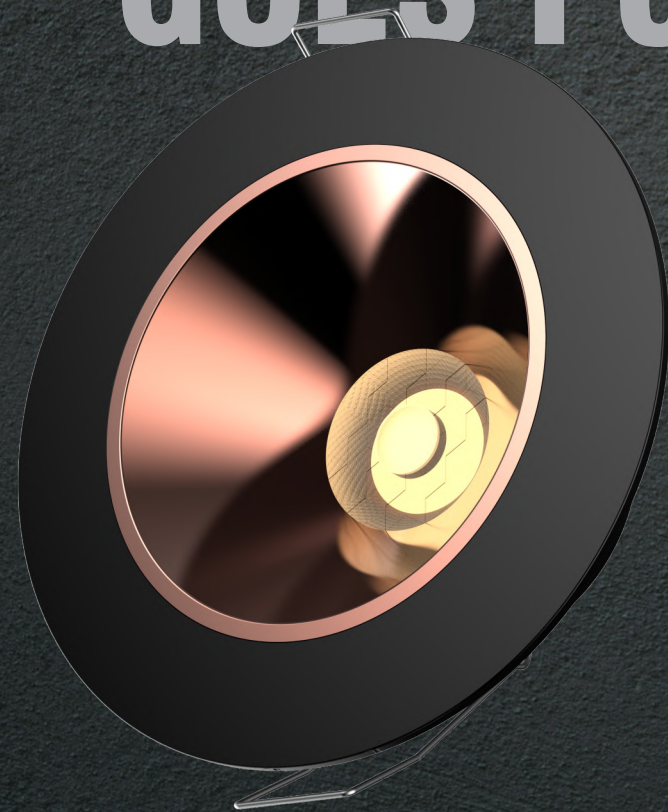

WHAT A BRIGHT IDEA



CODE	PRODUCT	COLOR	CUT-OUT	DIMENSIONS	WARRANTY	MRP(₹)	PKG (UNITS)
------	---------	-------	---------	------------	----------	--------	-------------

**CONCEALED BOX LIGHT - 4 INCH**

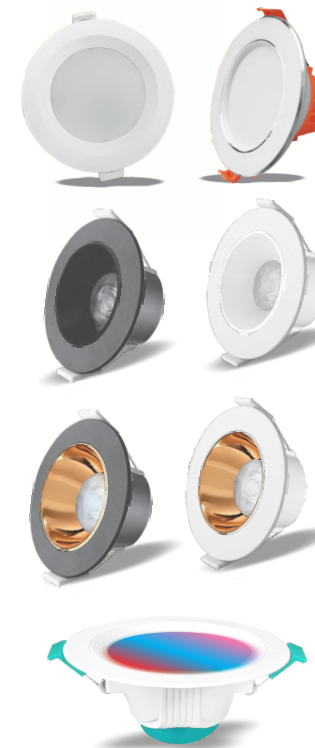

920	7 WATT ZIA	W.W, C.W, N.W, RED, GREEN, BLUE, PINK	75 MM	110 X 32 MM	2 YEARS	196.00	100
921	9 WATT ALUMINIUM	W.W, C.W, N.W	75 MM	110 X 45 MM	2 YEARS	276.00	50
976	7 WATT PRIMA	W.W, C.W, N.W, Body Color : Black/White	75 MM	110 X 45 MM	2 YEARS	274.00	50
977	7 WATT PRIMA FANCY	W.W, C.W, N.W, Body Color : Black/White + Gold/GunMetal	75 MM	110 X 45 MM	2 YEARS	320.00	50
978	8 WATT LVA 3 IN 1	W.W+C.W+N.W	75 MM	110 X 45 MM	2 YEARS	251.00	50

**JUNCTION BOX LIGHT**



922	3 WATT DEEP J LIGHT	W.W, C.W, N.W, RED, GREEN, BLUE, PINK	50 MM	80 X 35 MM	2 YEARS	130.00	100
980	3 WATT DEEP J LIGHT 3 IN 1	W.W+C.W+N.W	50 MM	80 X 35 MM	2 YEARS	186.00	50
923	7 WATT DEEEP J LIGHT	W.W, C.W, N.W	50 MM	47 X 54 MM	2 YEARS	227.00	50

**CONCEALED AND JUNCTION BOX LIGHT**



924	12 WATT	W.W, C.W, N.W	50 MM	115 X 46 MM	2 YEARS	401.00	20
925	15 WATT	W.W, C.W, N.W	50 MM	140 X 52 MM	2 YEARS	575.00	30

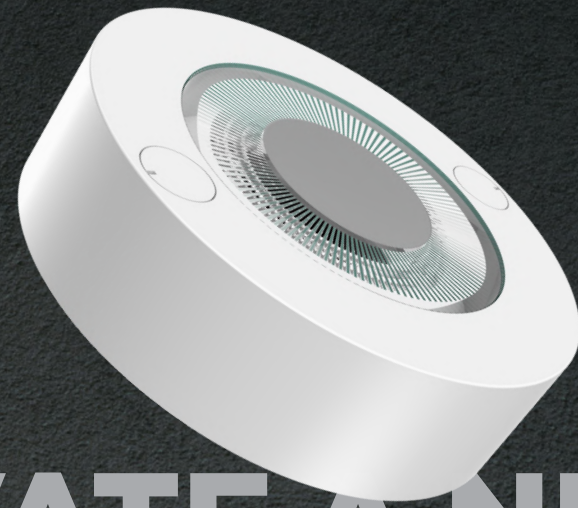

INNOVATE A NEW  
LIGHTING TO  
YOUR HOME



WHAT A BRIGHT IDEA



CODE	PRODUCT	COLOR	CUT-OUT	DIMENSIONS	WARRANTY	MRP (₹)	PKG (UNITS)
------	---------	-------	---------	------------	----------	---------	-------------



**STRICKER**

926	3WATT SPOT STRICKER	W.W, C.W, N.W,		61 X 17 MM	2 YEARS	164.00	100
927	5WATT STRICKER	W.W, C.W, N.W, RED, GREEN, BLUE, PINK		67 X 13 MM	2 YEARS	142.00	100
928	7WATT SHINE SURFACE	W.W, C.W, N.W		85 X 37 MM	2 YEARS	270.00	50



**2 IN 1 DEEP JUNCTION**

929	8 + 8 WATT DEEP JUNCTION	C.W + PBG	50 MM	88 X 41 MM	2 YEARS	321.00	20
930	12 + 12 WATT DEEP JUNCTION	C.W + PBG	50 MM	115 X 46 MM	2 YEARS	517.00	20



**2 PIN NIGHT LAMP**

931	0.5 WATT	W.W, C.W, N.W, RED, GREEN, BLUE, PINK		41 X 26 MM	1 YEARS	82.00	100
-----	----------	--	--	------------	---------	-------	-----



**BLUB**

981	0.5 WATT	W.W, C.W, N.W, RED, GREEN, BLUE, PINK	---	---	1 YEARS	50.00	200
932	9 WATT	W.W, C.W,	---	---	1 YEARS	110.00	50
933	15 WATT	C.W,	---	---	1 YEARS	206.00	40
934	20 WATT	C.W			1 YEARS	321.00	30





# Lights To Illuminate Homes & Hearts



WHAT A BRIGHT IDEA



CODE	PRODUCT	COLOR	WARRANTY	MRP (₹)	PKG (UNITS)
------	---------	-------	----------	---------	-------------

## HIGH WATTAGE BULB

935	30 WATT	C.W	1 YEARS	458.00	20
936	40 WATT	C.W	1 YEARS	614.00	20
937	50 WATT	C.W	1 YEARS	802.00	20
982	60 WATT	C.W	1 YEARS	1090.00	20



## INVERTER BULB (3 STEP)

938	9 WATT	C.W	1 YEARS	505.00	100
983	15WATT	C.W	1 YEARS	796.00	50
984	20WATT	C.W	1 YEARS	1029.00	20
985	30WATT	C.W	1 YEARS	1515.00	20



## BATTEN

986	15 WATT 2 FT	C.W , W.W	1 YEARS	252.00	40
939	20 WATT	C.W	1 YEARS	300.00	40
940	40 WATT	C.W	1 YEARS	673.00	25
987	70 WATT	C.W	1 YEARS	1752.00	20
988	100 WATT	C.W	1 YEARS	2263.00	20



## BULK HEAD

941	10 WATT	C.W	2 YEARS	311.00	50
942	20 WATT	C.W	2 YEARS	457.00	50
1017	25W FANCY BULK HEAD	C.W , W.W	2 YEARS	642.00	25



**Unwind  
Under  
the Glow.**



CODE	PRODUCT	COLOR	WARRANTY	MRP (₹)	PKG (UNITS)
------	---------	-------	----------	---------	-------------

### LINEAR LIGHT

990	50W 3 IN 1	W.W+C.W+N.W	2 YEARS	1322	20
-----	------------	-------------	---------	------	----

### STRIP LIGHTS (5 MTRS)

943	120 LED/ METER 12V	W.W, C.W, N.W, ICE BLUE, AMBER RED, GREEN, BLUE, PINK	2 YEARS	597.00	50
944	240 LED/ METER 12V	W.W, C.W, N.W	2 YEARS	929.00	50
991	60 LED/METER	RGB	2 YEARS	960.00	50
992	RGB ADAPTOR WITH REMOTE		2 YEARS	950.00	50

### STRIP LIGHT SMPS DRIVERS

945		3A - 36W	1 YEARS	496.00	1
946		5A - 60W	1 YEARS	637.00	1
947		8.3A - 100W	1 YEARS	897.00	1
948		16.5A - 200W	1 YEARS	1566.00	1
993		25A - 300W	1 YEARS	1859.00	1
994		33.3A - 400W	1 YEARS	2655.00	1

### ROPE LIGHT (50 MTRS) ROPE LIGHT ADAPTOR

949	120 LED/ METER	W.W, C.W, N.W, RED, GREEN, BLUE, PINK, ICE BLUE, AMBER	1 YEARS	6173.00	4
950	ADAPTOR		1 YEARS	137.00	100
995	120LED MULTI COLOR	RED+GREEN+BLUE+PINK ICE BLUE+AMBER	1 YEARS	6402.00	4
996	ADAPTOR MULTI COLOR		1 YEARS	229.00	100
997	60 LED - RGB 50 MTR	RGB	1 YEARS	13718.00	4
998	RGB ADAPTOR WITH REMOTE		1 YEARS	735.00	50



# TRACK LIGHT

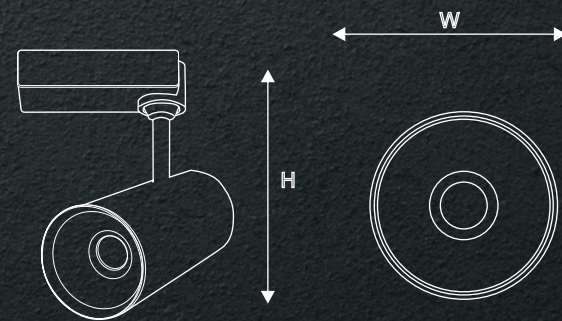

CODE	PRODUCT	COLOR	BODY COLOR	WARRANTY	MRP (₹)	PKG (UNITS)
------	---------	-------	------------	----------	---------	-------------

## TORCH AND RACKET

999	GLORY TORCH	N/A		1 YEARS	443.00	1
1000	MOSQUITO RACKET	N/A		1 YEARS	487.00	1



## TRACK LIGHT

1001	1 MTR		BLACK AND WHITE	N/A	326.00	40
1002	2 MTR		BLACK AND WHITE	N/A	652.00	40



## TRACK SPOT LIGHT

951	10 WATT	W.W, C.W, N.W	BLACK AND WHITE	2 YEARS	1143.00	20
952	20 WATT	W.W, C.W, N.W	BLACK AND WHITE	2 YEARS	1728.00	20
953	30 WATT	W.W, C.W, N.W	BLACK AND WHITE	2 YEARS	2080.00	20



## WALL SPOT LIGHT

973	10 WATT	W.W, C.W, N.W	BLACK AND WHITE	2 YEARS	1143.00	20
974	20 WATT	W.W, C.W, N.W	BLACK AND WHITE	2 YEARS	1728.00	20
975	30 WATT	W.W, C.W, N.W	BLACK AND WHITE	2 YEARS	2080.00	20





## WALL LAMPS



## PROFILES

CODE	PRODUCT	COLOR	WARRANTY	MRP (₹)	PKG (UNITS)
------	---------	-------	----------	---------	-------------

### WALL LAMPS

1028	WALL LIGHT - 1	C.W+W.W+N.W	N/A	1925.00	1
1029	WALL LIGHT - 2	C.W+W.W+N.W	N/A	2032.00	1
1030	WALL LIGHT - 3	C.W+W.W+N.W	N/A	2353.00	1

CODE	PRODUCT	WARRANTY	MRP (₹)	PKG (UNITS)
------	---------	----------	---------	-------------

### PROFILES

1031	17X6 CONCEALED 2 MTR	N/A	179.00	200
1032	17X6 CONCEALED 2 MTR (H.D)	N/A	389.00	200
1033	10X10 CONCEALED 2 MTR	N/A	283.00	200
1034	25X10 CONCEALED 2 MTR	N/A	309.00	100
1035	25X10 CONCEALED 2 MTR (H.D)	N/A	569.00	100
1036	17X6 SURFACE 2 MTR	N/A	179.00	200
1037	17X6 SURFACE 2 MTR (H.D)	N/A	356.00	200
1038	10X10 SURFACE 2 MTR	N/A	283.00	200
1039	25X10 SURFACE 2MTR	N/A	309.00	100
1040	25X10 SURFACE 2MTR (H.D)	N/A	434.00	100
1041	16X16 CORNER SURFACE 2MTR	N/A	283.00	200

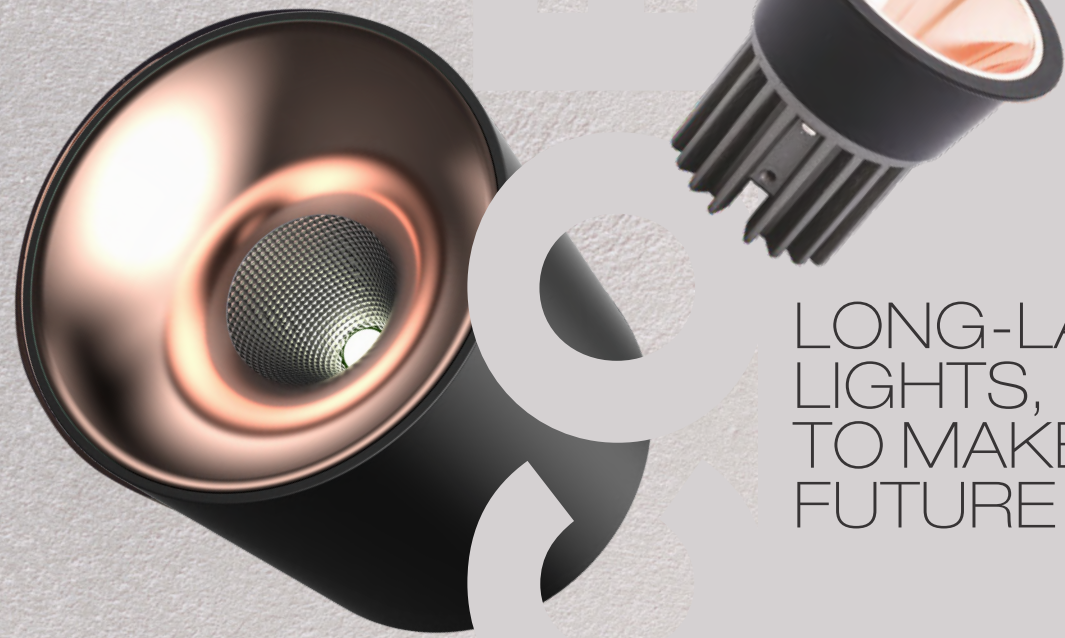

LONG-LASTING LIGHTS,  
TO MAKE YOUR FUTURE BRIGHT



WHAT A BRIGHT IDEA

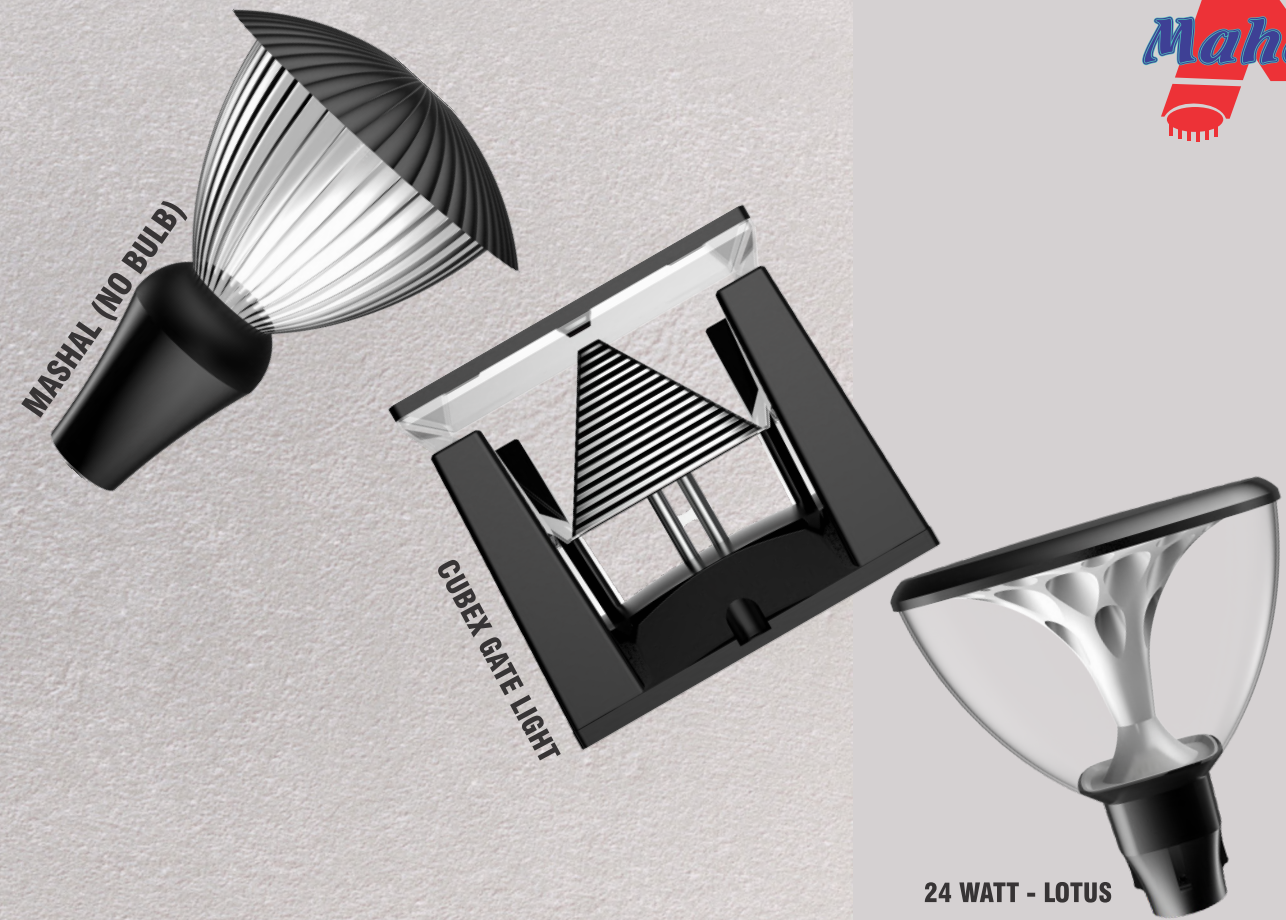

24 WATT - LOTUS

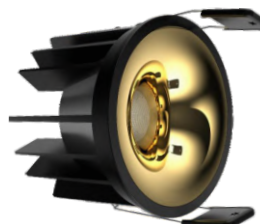
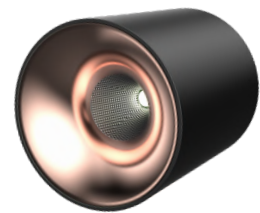

CODE	PRODUCT	COLOR	BODY COLOR	CUT-OUT	WARRANTY	MRP (₹)	PKG (UNITS)
------	---------	-------	------------	---------	----------	---------	-------------

**COB SURFACE CYLINDER**

954	7 WATT	W.W, C.W, N.W	WT, BK + GOLD, GUNMETAL		2 YEARS	814.00	20
955	12 WATT	W.W, C.W, N.W	WT, BK + GOLD, GUNMETAL		2 YEARS	1006.00	20
956	18 WATT	W.W, C.W, N.W	WT, BK + GOLD, GUNMETAL		2 YEARS	1367.00	20

**DEEP COB ALUMINIUM**

957	7 WATT	W.W, C.W, N.W	WHITE, BLACK	50 MM	2 YEARS	645.00	20
958	12 WATT	W.W, C.W, N.W	WHITE, BLACK	75 MM	2 YEARS	800.00	20
959	12 WATT METALLICA SERIES	W.W, C.W, N.W	WHITE, BLACK	75 MM	2 YEARS	915.00	20
960	18 WATT	W.W, C.W, N.W	WHITE, BLACK	80 MM	2 YEARS	1143.00	20

**BLISS COB DOWN LIGHT**

1005	7 WATT	W.W, C.W, N.W	WT, BK + GOLD, GUNMETAL	50 MM	2 YEARS	664.00	20
1006	12 WATT	W.W, C.W, N.W	WT, BK + GOLD, GUNMETAL	75 MM	2 YEARS	797.00	20
1007	18 WATT	W.W, C.W, N.W	WT, BK + GOLD, GUNMETAL	75 MM	2 YEARS	1018.00	20

CODE	PRODUCT	WARRANTY	MRP (₹)	PKG (UNITS)
------	---------	----------	---------	-------------

**GATE LIGHT**

1008	MASHAL (NO BULB)	1 YEAR	1086.00	4
1009	CUBEX GATE LIGHT	1 YEAR	1581.00	4
1010	24 WATT - LOTUS	1 YEAR	2595.00	4



## MIRROR LIGHTS



48W 2X2 PANNEL

CODE	PRODUCT	COLOR	WARRANTY	MRP(₹)	PKG (UNITS)
------	---------	-------	----------	--------	-------------

### MIRROR LIGHTS

1023	9W 3 IN 1	CW+WW+NW	1 YEARS	1106.00	10
1024	12W 3 IN 1	CW+WW+NW	1 YEARS	1726.00	10
989	48W 2X2 PANNEL	C.W	1 YEARS	2515.00	10



- Waterproof
- Anti Jamming
- Optical Lenses
- High Quality Led Patches
- Reduce Light Decay
- High Quality Rubber
- Ring To Prevent Leakage

# OUTDOOR LIGHTS

A nighttime photograph of a city skyline, likely Beijing, featuring several prominent skyscrapers illuminated with blue and white lights. The central focus is the CCTV New Building, a distinctive structure with a large rectangular cutout. The sky is a deep, dark blue. The title 'OUTDOOR LIGHTS' is overlaid on the image in a large, glowing blue font for 'OUTDOOR' and a white font for 'LIGHTS'. The overall mood is modern and urban.



## ZENIA FLOOD LIGHT

- Special Features:
- ENERGY SAVING (85% energy saving)
  - EXCELLENT CRI
  - LONGER-LIFE (Up to 40,000 Burning Hours\*)
  - HIGH LUMEN
  - EASY FIT (into false ceiling)
  - SURGE SHIELD (Up to 2.5 kV\*\*)
  - NO HARMFUL UV/IR Radiation



Special Features:

- ENERGY SAVING (85% energy saving)
- EXCELLENT CRI
- LONGER-LIFE (Up to 40,000 Burning Hours\*)
- HIGH LUMEN
- EASY FIT (into false ceiling)
- SURGE SHIELD (Up to 2.5 kV\*\*)
- NO HARMFUL UV/IR Radiation

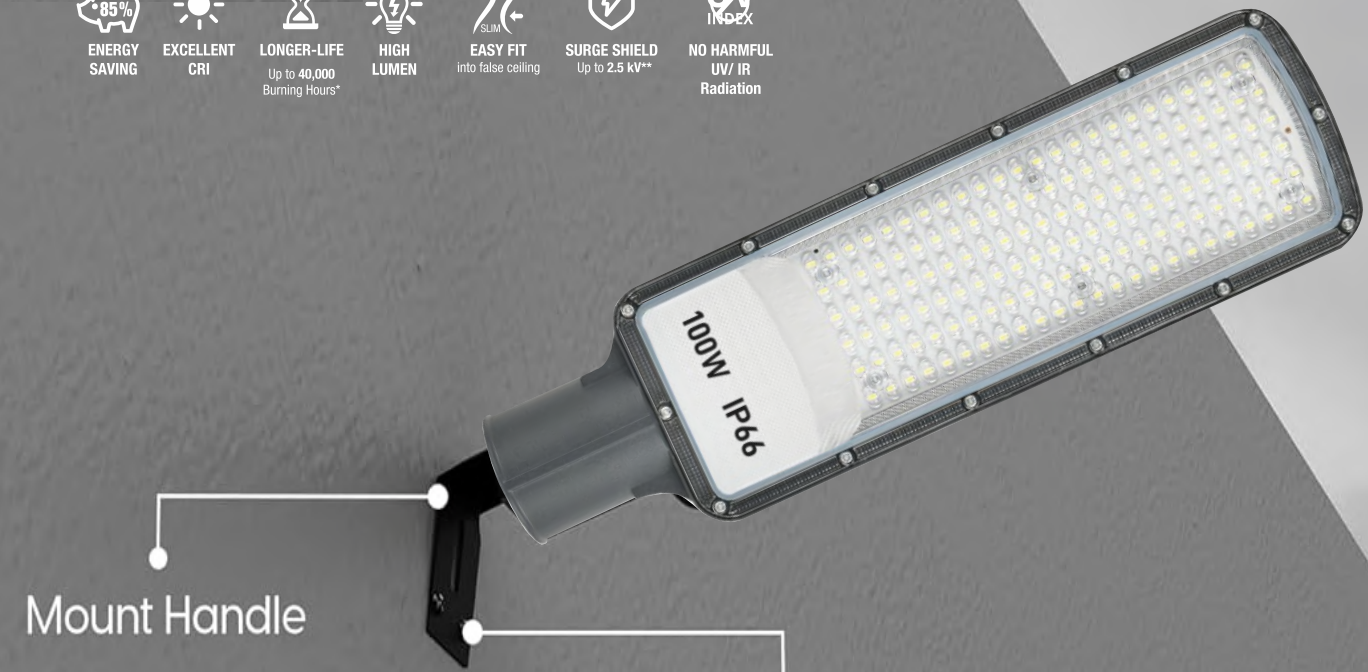

Mount Handle

Screw

## ARYA STREET LIGHT

CODE	PRODUCT	DIMENTIONS	WARRANTY	MRP(₹)	PKG (UNITS)
------	---------	------------	----------	--------	-------------

### ZENIA FLOOD LIGHT

961	30 WATT	150 X 120 X 15 MM	2 YEARS	1086.00	30
962	50 WATT	215 X 150 X 15 MM	2 YEARS	1329.00	30
963	100 WATT	280 X 175 X 15 MM	2 YEARS	2384.00	20
1004	150 WATT	325 X 250 X 15 MM	2 YEARS	3823.00	10
964	200 WATT	325 X 250 X 15 MM	2 YEARS	4868.00	10

CODE	PRODUCT	DIMENTIONS	WARRANTY	MRP(₹)	PKG (UNITS)
------	---------	------------	----------	--------	-------------

### ARYA STREET LIGHT

965	24 WATT	115 X 290 X 50 MM	2 YEARS	1120.00	30
966	36 WATT	120 X 320 X 50 MM	2 YEARS	1326.00	20
967	50 WATT	165 X 400 X 50 MM	2 YEARS	1738.00	20
968	100 WATT	200 X 385 X 60 MM	2 YEARS	2950.00	10

**Lighting That  
Makes A Difference**



Special Features:

- ENERGY SAVING**  
\*85%
- EXCELLENT CRI**
- LONGER-LIFE**  
Up to 40,000 Burning Hours\*
- HIGH LUMEN**
- EASY FIT**  
into false ceiling
- SURGE SHIELD**  
Up to 2.5 kV\*\*
- NO HARMFUL UV/ IR Radiation**

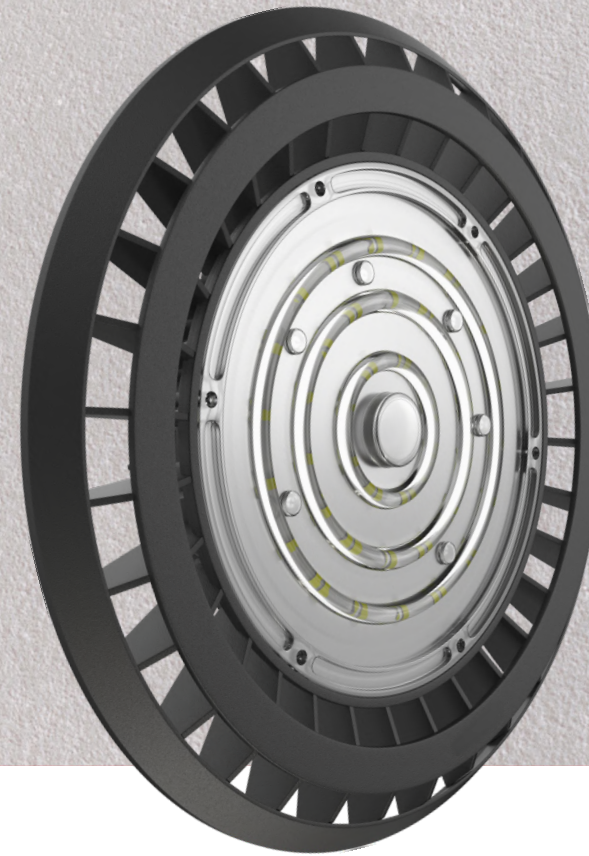

## UFO HIGH BAY LIGHT

Special Features:

- ENERGY SAVING**  
\*85%
- EXCELLENT CRI**
- LONGER-LIFE**  
Up to 40,000 Burning Hours\*
- HIGH LUMEN**
- EASY FIT**  
into false ceiling
- SURGE SHIELD**  
Up to 2.5 kV\*\*
- NO HARMFUL UV/ IR Radiation**

### SOLAR STREET LGHT

CODE	PRODUCT	BATTERY	WARRANTY	MRP (₹)	PKG (UNITS)
1025	60 WATT	10,000 MAH	1 YEARS	6084.00	10
1026	100 WATT	16,000 MAH	1 YEARS	8120.00	5
1027	200 WATT	20,000 MAH	1 YEARS	10266.00	5

### UFO HIGH BAY LIGHT

CODE	PRODUCT	WARRANTY	MRP (₹)	PKG (UNITS)
969	50 WATT	2 YEARS	4458.00	8
970	100 WATT	2 YEARS	5098.00	5
971	150 WATT	2 YEARS	7522.00	5
972	200 WATT	2 YEARS	8472.00	5
1003	300 WATT	2 YEARS	15930.00	4

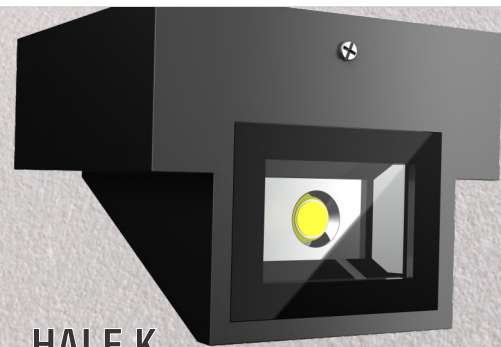

HALF K



FULL K



2W 2 WAY



6W 2 WAY - RGBP

4W 4 WAY  
BALL - RGBP

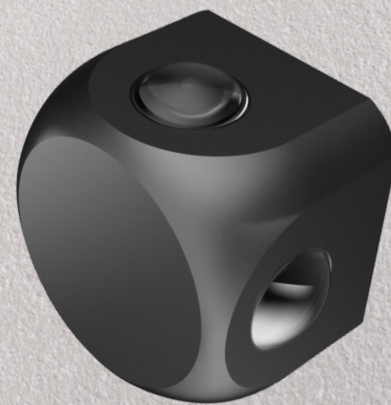

10W 5 WAY WALL LIGHT

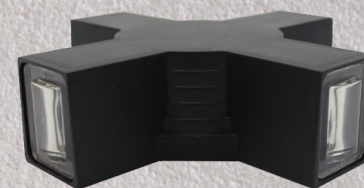

8W 4 WAY RAYZ



10W 2 WAY CUSTOM

CODE	PRODUCT	COLOR	WARRANTY	MRP (₹)	PKG (UNITS)
1011	HALF K	W.W	2 YEARS	562.00	25
1012	FULL K	W.W	2 YEARS	642.00	25
1013	2W 2 WAY	W.W	2 YEARS	553.00	25
1014	4W 2 WAY	W.W	2 YEARS	620.00	25
1015	6W 2 WAY	W.W	2 YEARS	841.00	25
1016	6W 2 WAY - RGBP	RGPB	2 YEARS	885.00	25

CODE	PRODUCT	COLOR	WARRANTY	MRP (₹)	PKG (UNITS)
1018	4W 4 WAY BALL	W.W	2 YEARS	628.00	25
1019	4W 4 WAY BALL - RGBP	RGPB	2 YEARS	673.00	25
1020	10W 5 WAY WALL LIGHT	W.W	2 YEARS	575.00	25
1021	8W 4 WAY RAYZ	W.W	2 YEARS	553.00	25
1022	10W 2 WAY CUSTOM	W.W	2 YEARS	553.00	25